

See discussions, stats, and author profiles for this publication at: <https://www.researchgate.net/publication/334088605>

# Mathematical Modeling in Combining Photovoltaic and Thermoelectric Generator using a Spectrum Splitter

Article in *EPI International Journal of Engineering* · June 2019

DOI: 10.25042/eji-ije.022019.13

CITATIONS

7

READS

188

4 authors:



**Hariyanto Hariyanto**

Universitas Musamus Merauke Indonesia

23 PUBLICATIONS 47 CITATIONS

[SEE PROFILE](#)



**Mus Tofa**

Universitas Tadulako

32 PUBLICATIONS 64 CITATIONS

[SEE PROFILE](#)



**Zuryati Djafar**

Universitas Hasanuddin

47 PUBLICATIONS 130 CITATIONS

[SEE PROFILE](#)



**Wahyu H. Piarah**

Universitas Hasanuddin

49 PUBLICATIONS 222 CITATIONS

[SEE PROFILE](#)

Some of the authors of this publication are also working on these related projects:



Potential of New and Renewable Energy [View project](#)



Light energi [View project](#)

# Mathematical Modeling in Combining Photovoltaic and Thermoelectric Generator Using a Spectrum Splitter

Hariyanto<sup>a</sup>, Mustofa<sup>b\*</sup>, Zuryati Djafar<sup>c</sup>, Wahyu H. Piarah<sup>d</sup>

<sup>a</sup>Department of Mechanical Engineering, Engineering Faculty, Musamus University, Merauke, Indonesia. Email: hryengine@gmail.com

<sup>b</sup>Department of Mechanical Engineering, Engineering Faculty, Universitas Tadulako, Palu, Indonesia. Email: mustofauntad@gmail.com

<sup>c</sup>Department of Mechanical Engineering, Engineering Faculty, Universitas Hasanuddin, Gowa, Indonesia. Email: zuryatidjafar@unhas.ac.id

<sup>d</sup>Department of Mechanical Engineering, Engineering Faculty, Universitas Hasanuddin, Gowa, Indonesia. Email: wahyupiarah@unhas.ac.id

---

## Abstract

The experimental stages of converting solar energy into electrical energy in Photovoltaic and Thermoelectric Generator (PV-TEG) hybrid takes a long time. Mathematical modeling is an approach to find out the initial data before conducting experiments leading to minimized design errors, time and budget. The mathematical model is created to analyze the performance of a PV-TEG hybrid module. Modeling is performed as an electrical circuit equivalent to Kirchoff's Current Law (KCL) by deriving several equations corresponding to the characteristics of each module. Type of PV is amorphous Silicon (a-Si), while TEG is Bismuth Telluride (Bi<sub>2</sub>Te<sub>3</sub>). The AM1.5D standard solar spectrum is split its wavelength using hot mirror, where the wavelengths of 400-690 nm are transmitted to PV and 690-1150 nm are reflected to TEG. All of the PV-TEG hybrid parameters, for example intensity, temperature, and material property are obtained from the specification data of each module. As a result, the maximum total power is 0.1710 W with 5.1% of its efficiency.

*Keywords:* Photovoltaic; power output; spectrum splitter; thermoelectric generator

---

## 1. Introduction

Solar energy is a renewable energy source that continues to be developed to meet future energy needs. The light and thermal produced by the solar energy can be used for daily living needs. Photovoltaics (PV) and thermoelectric generator (TEG) are devices whose utilization have been developed to convert light and heat into electrical energy. PV can absorb up to 80% of solar radiation, but not all can be converted into electrical energy, partly are discharged into waste heat which can increase the temperature of the cell and ultimately cause a decrease in efficiency [1]. Waste heat which is wasted due to increasing temperature can be utilized by using a thermoelectric [2]. TEG is a power generating device that converts heat energy into electrical energy due to temperature differences between the hot side and the cold side [3]. The development of research combining stacked PV-TEG integration has been done experimentally to observe the maximum work of PV and TEG [4–6], and simulations with mathematical modeling with the help of Matlab/simulink and experiments carried out by Babu and Ponnambalam [7].

While research with hybrid PV-TEG mathematical modeling that splits the light spectrum is still rarely conducted. Actually the basic idea about spectrum splitting was already introduced by Tritt et al. [8] in a bulletin, the study was expanded by Kraemer et al. [9] by varying PV in 3 types of solar cells (a-Si: H, mc-Si; H and polymer) and 1 type of TEG. Unfortunately, the radiation source that came AM1.5G was not concentrated before reaching the spectrum splitter and the type of splitter itself was not written on the specification of its light transmission power, as done Ju et al. [10]. Experimented in closed spaces, the latest research on PV-TEG hybrid using Hot mirror spectrum splitter has been carried out by Mustofa et al. [11] which utilizes artificial light spectrum radiation sources known as artificial sun, namely Xenon, Halogen and Incandescent bulbs whose lights concentrated with Fresnel lenses before reaching the splitter (Hot mirror). The concentrated light is divided according to its wavelength in order to adjust to the needs of the PV module and TEG. However, the results only described radiant heat and wavelengths of lights, while inputs from radiation and wavelengths did not describe the characteristics of each PV and TEG.

---

\*Corresponding author. Tel.: +62-813-4107-4257  
Palu, Sulawesi Tengah, Indonesia  
94118

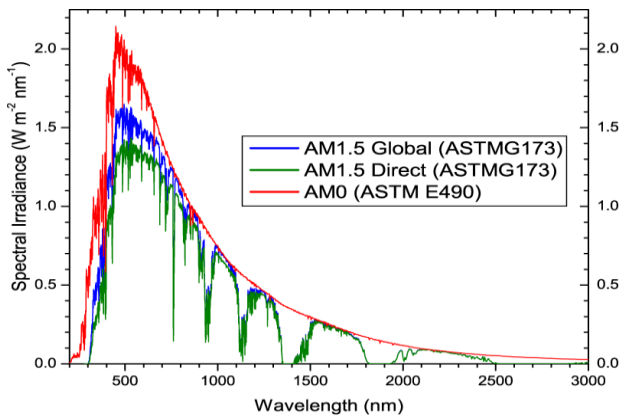

Figure 1. AM1.5 Global Sun Spectrum Measurement (ASTMG173), AM1.5 Direct (ASTMG173) and AM0 (ASTM E490) [15]

Mathematical modeling has been made to see the characteristics of PV [12, 13] and TEG has been carried out by Rukdq et al. [14], by inserting the required input parameters. Therefore, in this paper the author conducts modeling by combining the PV mathematical model and TEG which describe the characteristics of each module. The used radiation source is a standard spectrum AM1.5D (GSTM1730) with 1 Sun. The radiation that comes is focused by using Fresnel lens and then split by hot mirror. Radiation spectrum wavelengths are adjusted according to the needs of PV and TEG modules, amorphous Silicon; (a-Si) and Bismuth Telluride (Bi2Te3), respectively.

## 2. Spectrum AM1.5D (GSTM1730)

Figure 1 shows the data measured by the solar spectrum at STC (standard test condition). AM0 is red color (ASTM E490), AM1.5 Global blue color (ASTMG173) and AM1.5Direct is green color (ASTMG173) [15].

The AM1.5 Global (ASTMG173) spectrum is a spectrum designed for flat plate modules and has an integrated power of 1000 W/m<sup>2</sup>. AM1.5 Direct (ASTMG173) is a spectrum designed for solar concentrators, with additional circumference and has an integrated power of 900 W/m<sup>2</sup>. AM0 (ASTM E490) is a standard spectrum for aerospace applications with integrated power of 1366.1 W/m<sup>2</sup> [15].

The total power density emitted from the light source can be calculated by integrating spectral irradiation into all wavelengths or energies expressed in equation [16]:

$$H = \int_0^{\infty} F(\lambda) d\lambda \quad (1)$$

Where  $H$  is the total power density emitted from the light source in Wm<sup>-2</sup>,  $F(\lambda)$  is spectral radiation in units of Wm<sup>-2</sup> μm<sup>-1</sup> and  $d\lambda$  is the wavelength with units of nm.

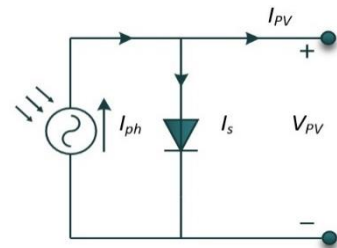

Figure 2. PV cell circuit model ideal

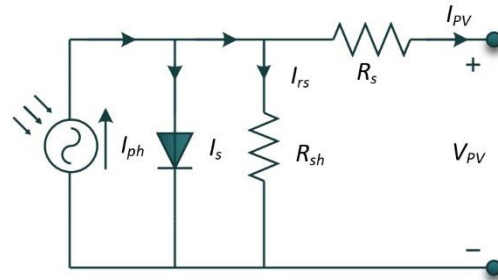

Figure 3. PV cell circuit model in one diode

## 3. Model of PV

The electrical circuit used to model the PV module is illustrated as shown in Fig. 2 below. The use of the equivalent KCL list (Kirchoff's Current Law) makes it possible to create characteristic models of PV. The ideal PV cell model is a circuit model that ignores the presence of obstacles in the device, so that current flows only through ideal diodes as shown in Fig. 2 [13].

It can be seen that the ideal PV cell series model can be expressed in equation [13]:

$$I_{pv} = I_{ph} - I_s \quad (2)$$

where  $I_{pv}$  is the PV output current,  $I_{ph}$  is the current of the photon that is generated and  $I_s$  is the diode current. While the real PV cell model one diode is done by adding obstacles to the circuit. The obstacles applied to the circuit are divided into two obstacles, namely series and parallel barriers as shown in Fig. 3 [13].

The equation of the voltage current meets in Fig. 3, which represents an equivalent circuit according to Kirchoff's law and expressed as [13]:

$$I_{pv} = I_{ph} - I_s - I_{rs} \quad (3)$$

$I_{rs}$  is the current on the added obstacle. The current of the generated photon is expressed by equation [12]:

$$I_{ph} = [I_{sc} + K_i(T - T_0)] \left( \frac{G}{G_0} \right) \quad (4)$$

$I_{sc}$  is short circuit current,  $K_i$  is current conductivity,  $T$  is PV temperature,  $G$  is irradiation,  $T_0$  and  $G_0$  are temperature and irradiation at STC (Standard test Condition) based on international standard IEC (International Electrotechnical Commission).  $T_0 = 25$  °C

and  $G_0 = 1000 \text{ W/m}^2$ . The resistance current is expressed in the equation [12]:

$$I_{rs} = I_{scr} \left[ \exp\left(\frac{qV_{oc}}{N_s kAT}\right) - 1 \right] \quad (5)$$

$I_{scr}$  is a standard short current current,  $V_{oc}$  is an open circuit voltage,  $q$  is an electron charge ( $1.602 \times 10^{-19} \text{ C}$ ),  $N_s$  is the number of series cells in a PV module,  $k$  is a Boltzman constant ( $1.38 \times 10^{-23} \text{ J}$ ),  $A$  is a factor ideal diode. While the diode current is expressed as [12]:

$$I_s = I_{rs} \left(\frac{T}{T_0}\right)^3 \exp\left[\frac{qE_g}{Ak} \left(\frac{1}{T_0} - \frac{1}{T}\right)\right] \quad (6)$$

$E_{gp}$  is the band gap energy, so equation (2) becomes [12]:

$$I_{pv} = N_p I_{ph} - N_p I_d \left[ \exp\left(\frac{qV_{vp} + I_{pv} R_s}{N_s kAT}\right) - 1 \right] - \frac{V_{vp} + I_{pv} R_s}{R_h} \quad (7)$$

$R_s$  is the series resistance and  $R_h$  is a parallel resistance. The parameters  $A$ ,  $I_{ph}$ ,  $I_d$ ,  $R_s$ ,  $R_h$ , are called PV cell internal parameters. The PV module consists of PV cells that are connected and can be arranged in series, parallel and combination.

Input power due to irradiation from light sources can be calculated by the following equation [13]:

$$P_{in} = GA_{pv} \quad (8)$$

$A_{pv}$  is the surface area of a PV module. To evaluate the quality of PV cells in the filling factor with the equation [13]:

$$FF = \frac{I_{MP} V_{MP}}{I_{sc} V_{oc}} \quad (9)$$

$I_{MP}$  is the current at maximum power,  $V_{MP}$  voltage at maximum power. While the maximum efficiency of PV is expressed as an equation [13]:

$$\eta_{pv} = \frac{I_{MP} V_{MP}}{GA_{pv}} \quad (10)$$

In general, the characteristics of PV can be seen in the I-V current and voltage curves, using the maximum power I-V curve can be determined at the maximum power point and voltage at the maximum power point. As shown in Fig. 4. The red I-V curve and the blue P-V curve [17].

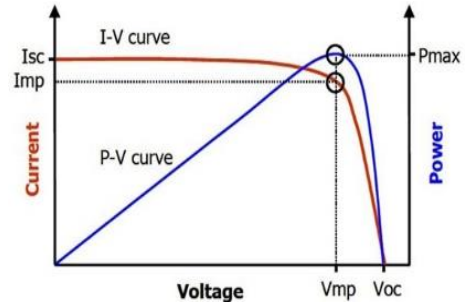

Figure 4. PV curve : I-V (red) dan P-V(blue) curve [17]

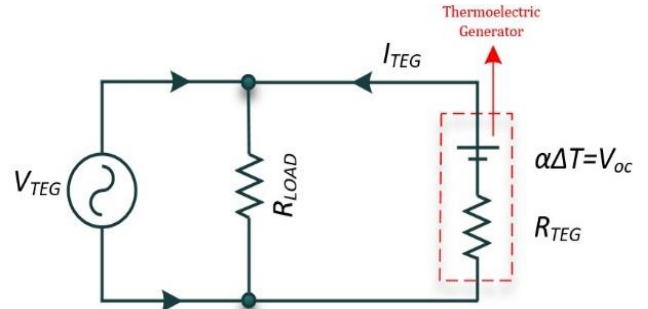

Figure 5. TEG circuit model

#### 4. Model of PV

The model for measuring electrical power in TEG can be described by  $V_{oc}$  open circuit voltage and the value of TEG electrical resistance. Internal resistance is determined in maximized electrical power as shown in Fig. 5 [18].

Based on Fig. 5, Voltage is generated by the Seebeck effect on TEG. The heat absorbed is expressed as an equation [14]:

$$Q_H = \alpha I T_H + K(T_H - T_C) - 0.5 R I^2 \quad (11)$$

Where  $\alpha$  is the Seebeck coefficient,  $R$  is the internal resistance,  $K$  is thermal conductivity. While for the calculation of voltage current is expressed as [14]:

$$V_{oc} = \alpha \Delta T \quad (12)$$

Where  $V_{oc}$  is the open circuit voltage,  $\alpha$  is the Seebeck coefficient of semiconductor material and  $\Delta T$  is the temperature between the hot side and the cold side of TEG. The currents generated from TEG are expressed as equations [14]:

$$I_{TEG} = \frac{\alpha \Delta T}{R_{TEG} + R_{LOAD}} \quad (13)$$

where  $R_{TEG}$  is an internal TEG obstacle and  $R_{LOAD}$  external constraints are given.

If  $V_{TEG} = I_{TEG} R_{TEG}$  then :

$$V_{TEG} = \frac{\alpha \Delta T}{R_{TEG} + R_{LOAD}} R_{LOAD} \quad (14)$$

So that the power that can be generated by TEG [14]:

$$P_{TEG} = V_{TEG} I_{TEG} \tag{15}$$

Efficiency can be calculated by equation [14]:

$$\eta_{TEG} = \frac{V_{TEG} I_{TEG}}{Q_H} \tag{16}$$

### 5. PV-TEG Performance

The types of devices used are commercial amorphous silicon (a-Si) PV [19], TEG type Bismuth Telluride (Bi2Te3) [20] and hot mirror 40x40 mm from Edmund optic, where the specifications are shown in Table 1-3. Furthermore, the schematic calculation of the PV-TEG hybrid can be seen in Fig. 6.

For determining PV-TEG hybrid output power can be referred to Babu and P. Ponnambalam [7] as follows:

$$P_{PV-TEG} = P_{PV} + P_{TEG} \tag{17}$$

Where  $P_{PV}$  is the output power of PV and  $P_{TEG}$  is the output power of TEG, while its efficiency is:

$$\eta_{PV-TEG} = \eta_{PV} + \eta_{TEG} \tag{18}$$

Where  $\eta_{PV}$  and  $\eta_{TEG}$  are the efficiency of PV and TEG module, respectively.

Figure 6 shows the scheme and stages of PV-TEG hybrid mathematical modeling calculations. Power output and overall efficiency are the sum of PV output with TEG output.

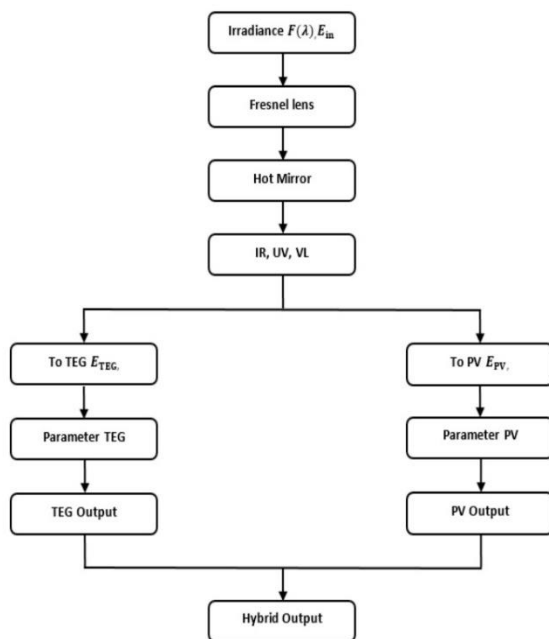

Figure 6. Schematic Calculation of PV-TEG hybrids

Figure 7 shows the results of the AM1.5D data spectrum calculation (ASTMG173) after illuminating the hot mirror. The solar spectrum transmitted in the form of visible (Vis) and ultraviolet (UV) lights to PV is = 362.93 W/m<sup>2</sup> (at 400-690 nm) and reflected in the form of near-infrared (Nir) and infrared (IR) spectrums to TEG are = 311.62 W/m<sup>2</sup> (at 690-1150 nm). PV in the form of photons with low temperatures needs Vis and UV, while TEG needs NIR or IR in the form of thermal at high temperatures.

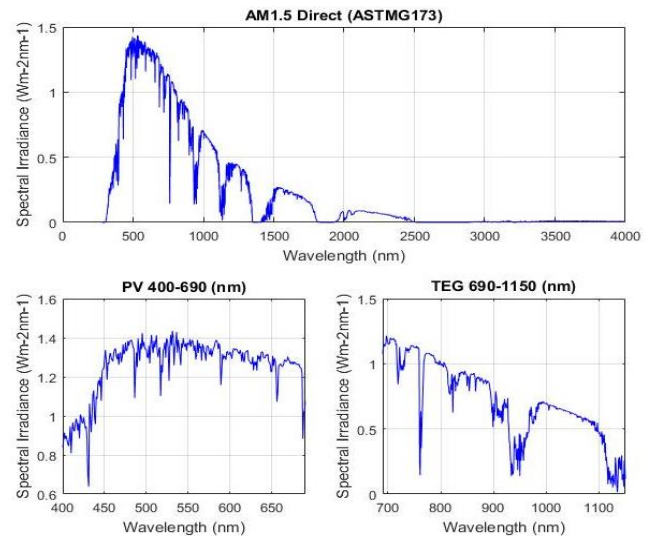

Figure 7. AM1.5D spectrum wavelength passes through a hot mirror

Table 1. Data Specifications of ASC 4040 [19]

Parameter	Value
Maximum Power (P)	0.082 W
Maximum Power voltage $V_{MP}$	1.85 V
Maximum Power current $I_{MP}$	0.044 A
Open circuit voltage ( $V_{oc}$ )	2.4 V
Short circuit current ( $I_{sc}$ )	0.054 A
Dimensions (L*W*H)	40*40*2 mm
Material : Amorphous silicon (a-Si)	
Electrical specifications at standard test conditions; irradiance of 1000 W/m <sup>2</sup> , spectrum of 1.5 air mass and cell temperature of 25° C.	

Table 2. Data Spesifikasi SP1848-27145 [20]

Parameter	Value
Voltage open circuit ( $V_{oc}$ )	0.97 V
Current (I)	0.225 A
Resistance	2.4 Ohm
Hot side temperature ( $T_H$ )	50 °C
Cold side temperature ( $T_C$ )	30 °C
Dimensions (L*W*H)	40*40*3.4 mm

Table 3. Data Specifications Hot Mirror [21]

Parameter	Value
Angle of incident (°C)	45
>90% Transmission from (nm)	400-690
>95% Reflections from (nm)	710-1150
Dimensions (L*W*H)	40*40*1 mm

### 6. Result and Discussion

The calculation results of the hybrid PV-TEG mathematical model based on equation (1-16) using the initial parameters of the specification data in Table 1-3 which can be seen in Figs. 8 and 9 in the form of I-V and P-V curves. Figure 8 shows the calculation results on the I-V curve in the PV module. The power transmitted from the hot mirror to PV is used as input to the irradiation value ( $G$ ) = 362.93 W/m<sup>2</sup>, resulting in a value of  $I_{sc}$  = 0.019 A and  $V_{oc}$  = 1.952 V.

Figure 9 shows the results of calculations on the P-V curve in the PV module. The power value is obtained by multiplying the voltage and current values. While constant values include: Boltzman constant ( $k$ ) = 1.38 x 10<sup>-23</sup>, Electron charge ( $q$ ) = 1.602 x 10<sup>-19</sup>, ideality factor diode ( $A$ ) = 1, Energy gap ( $E_{gp}$ ) = 1.5, Temperature ( $T$ ) = 25°C and produce  $I_{MP}$  = 0.015 A,  $V_{MP}$  = 1.394 V and  $P_{MP}$  = 0.021 W. While the efficiency produced is 3.6%. This result can also illustrate that the output value and efficiency of PV cells are very dependent on the value of the intensity and temperature given.

Figure 10 shows the calculation results on the I-V curve in the TEG module. The magnitude reflected from the hot mirror to TEG 311.62 W m<sup>2</sup> is assumed to provide thermal with a maximum value of  $\Delta T$  of 30°C. Under conditions of  $T_H$  = 60°C,  $T_C$  = 30°C,  $R_{TEG}$  = 3.7Ω

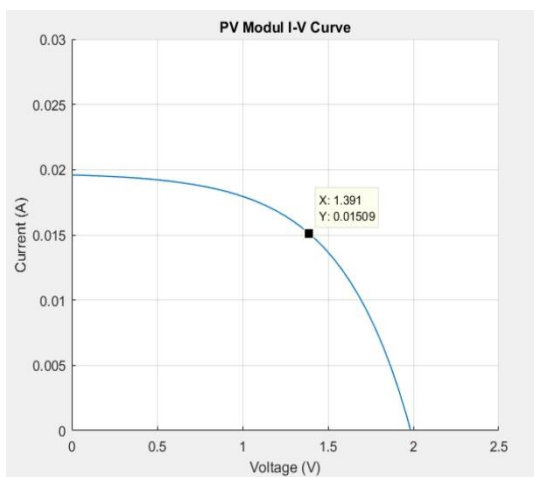

Figure 8. PV Modul I-V Curve

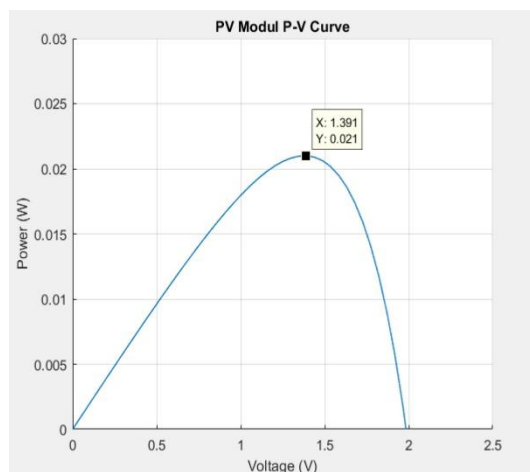

Figure 9. PV Modul P-V Curve

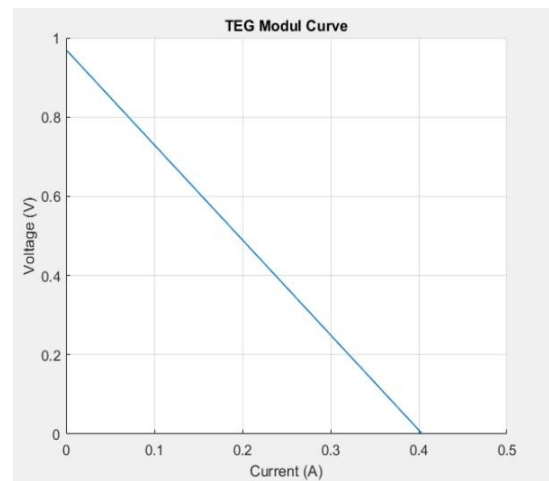

Figure 10. TEG Modul I-V Curve

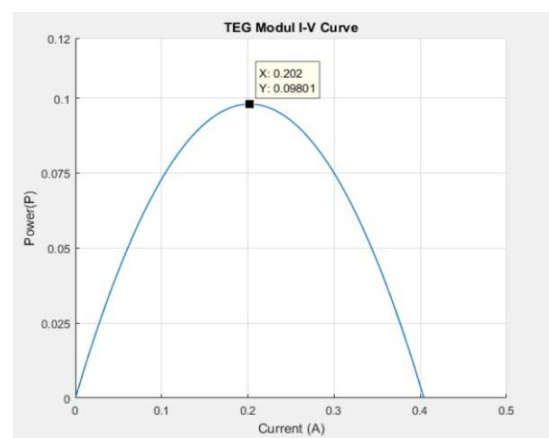

Figure 11. TEG Modul I-P Curve

and  $R_{LOAD}$  = 1-10Ω, produce  $I_{sc}$  = 0.404 A and  $V_{oc}$  = 0.967 V.

Figure 11 displays the results of calculations on the I-P curve. The maximum power value is obtained by multiplying the voltage and current values in the quadratic function. Resulting in the value  $I_{MP}$  = 0.202 A,  $V_{MP}$  = 0.073 V dan  $P_{MP}$  = 0.098 W. While the efficiency produced is 1.502 %. The characteristics of TEG as a power plant have quite important parameters that determine output power and efficiency including temperature differences between hot and cold sides, voltage and load [7]. The total output power and efficiency of Hybrid PV-TEG is the sum of the total power and efficiency produced by PV and TEG by  $P_{hybrid}$  = 0.1710 W and  $\eta_{hybrid}$  = 5.1 %.

### 7. Conclusion

The new mathematical modeling that characterizes PV-TEG hybrid using wavelength spectrum splitter of a hot mirror is presented. From the modeling results produce PV values;  $I_{MP}$  = 0.015 A,  $V_{MP}$  = 1.394 V and  $P_{MP}$  = 0.021 W and values at TEG  $I_{MP}$  = 0.202 A,  $V_{MP}$  = 0.073 V dan  $P_{MP}$  = 0.098 W. Total maximum power generated is 0.1710 W with an efficiency of 5.1%. The power output and efficiency of the hybrid PV are greatly influenced by irradiation and the temporal temperature in TEG is only influenced by differences in hot side

temperature and cold side. The magnitude of the AM1.5 D spectrum that can be utilized with the use of hot mirrors is only  $674.55 \text{ W/m}^2$  at wavelengths of 400-690 (visible light and UV) and  $690\text{-}1150$  (NIR and IR). The total total power is  $900 \text{ W/m}^2$  and is  $225.45 \text{ W/m}^2$  wasted environment. The choice of construction and material both PV and TEG needs to be considered because it influences internal factors such as material resistivity and thermal conductivity. This modeling still needs to be developed with other types of PV and TEG material to see the best ratio of output power and efficiency.

### Acknowledgements

Thank you to the BUDI-DN 2016 affirmation scholarship organizers and Musamus University (UNMUS), Merauke as a sponsor of this research.

### References

- [1] A. Makki, S. Omer, and H. Sabir, "Advancements in hybrid photovoltaic systems for enhanced solar cells performance," *Renew. Sustain. Energy Rev.*, vol. 41, pp. 658–684, 2015.
- [2] A. Kane and V. Verma, "Performance Enhancement of Building Integrated Photovoltaic Module using Thermoelectric Cooling," vol. 3, no. 2, 2013.
- [3] U. Syamsuddin, Z. Djafar, T. Tjandinegara, Z. Djafar, and W. H. Piarah, "Heat Utilization of Incinerator Chimneys as Mini Power Generator Based on Thermoelectric," *EPI Int. J. Eng.*, vol. 1, no. August 2018, pp. 51–58, 2018.
- [4] H. Chang, M. Kao, K. Cho, S. Chen, K. Chu, and C. Chen, "Integration of CuO thin films and dye-sensitized solar cells for thermoelectric generators," *Curr. Appl. Phys.*, vol. 11, no. 4, pp. S19–S22, 2011.
- [5] H. Chang and Z. Yu, "Integration of Dye-Sensitized Solar Cells, Thermoelectric Modules and Electrical Storage Loop System to Constitute a Novel Photothermoelectric Generator," vol. 12, no. 8, pp. 6811–6816, 2012.
- [6] Y. Li, S. Witharana, H. Cao, M. Lasfargues, Y. Huang, and Y. Ding, "Wide spectrum solar energy harvesting through an integrated photovoltaic and thermoelectric system," *Particuology*, vol. 15, pp. 39–44, 2014.
- [7] C. Babu and P. Ponnambalam, "The theoretical performance evaluation of hybrid PV-TEG system," *Energy Convers. Manag.*, vol. 173, no. April, pp. 450–460, 2018.
- [8] T. M. Tritt, H. Böttner, and F. Institut, "Thermoelectrics : Direct Solar Thermal Energy Conversion," vol. 33, no. APRIL, pp. 366–368, 2008.
- [9] D. Kraemer, L. Hu, A. Muto, X. Chen, G. Chen, and M. Chiesa, "Photovoltaic-thermoelectric hybrid systems: A general optimization methodology," *Appl. Phys. Lett.*, vol. 92, no. 24, pp. 23–25, 2008.
- [10] X. Ju, Z. Wang, G. Flamant, P. Li, and W. Zhao, "Numerical analysis and optimization of a spectrum splitting concentration photovoltaic – thermoelectric hybrid system," *Sol. Energy*, vol. 86, no. 6, pp. 1941–1954, 2012.
- [11] Mustofa, Z. Djafar, Syafaruddin, and W. H. Piarah, "A new hybrid of photovoltaic-thermoelectric generator with hot mirror as spectrum splitter," *J. Phys. Sci.*, vol. 29, pp. 63–75, 2018.
- [12] K. Nakagawa, T. Tanaka, and T. Suzuki, "Modelling of Photovoltaic Module Using Matlab Simulink."
- [13] Y. Belkassmi, A. Rafiki, K. Gueraoui, L. Elmaimouni, O. Tata, and N. Hassanain, "Modeling and simulation of photovoltaic module based on one diode model using Matlab/Simulink," *Proc. - 2017 Int. Conf. Eng. MIS, ICEMIS 2017*, vol. 2018–Janua, pp. 1–6, 2018.
- [14] F. Rukdq *et al.*, "Modeling and Simulation of Thermo Electrical Generator with MPPT," *ICRERA*, vol. 6, pp. 855–860, 2017.
- [15] C. Honsber and S. Bowden, "Standard Solar Spectra," *pveducation*, 2018. [Online]. Available: <https://www.pveducation.org/pvcdrom/appendices/standard-solar-spectra>. [Accessed: 11-Nov-2018].
- [16] C. Honsberg and S. Bowden, "Properties of Light," *pveducation*, 2018. [Online]. Available: <https://www.pveducation.org/pvcdrom/properties-of-sunlight/properties-of-light>.
- [17] B. Schweber, "Solar cells and power, Part 2 – power extraction," *powerelectronicstips*, 2017. [Online]. Available: <https://www.powerelectronicstips.com/solar-cells-power-part-2-power-extraction/>.
- [18] R. Mawi and Y. Kazuz, "Hybrid Solar Thermo-Electric Systems for Combined Heat and Power," no. September, 2014.
- [19] alibaba.com, "Data Sheet of PV ASC 4040," *alibaba.com*. [Online]. Available: [https://www.alibaba.com/product-detail/1W-small-size-customized-amorphous-silicon\\_60159308905.html?spm=a2700.7724857.normalList.49.3a24696eEpoJ6S](https://www.alibaba.com/product-detail/1W-small-size-customized-amorphous-silicon_60159308905.html?spm=a2700.7724857.normalList.49.3a24696eEpoJ6S). [Accessed: 11-Nov-2018].
- [20] alibaba.com, "Data Sheet of TEG SP1848-27145," *alibaba.com*, 2018. [Online]. Available: [https://www.alibaba.com/product-detail/Thermoelectric-Power-Generator-Peltier-Module-TEG\\_60707268580.html?spm=a2700.7724838.2017115.34.3c8d392fDqYIMv](https://www.alibaba.com/product-detail/Thermoelectric-Power-Generator-Peltier-Module-TEG_60707268580.html?spm=a2700.7724838.2017115.34.3c8d392fDqYIMv). [Accessed: 11-Nov-2018].
- [21] Edmund Optics, "Data Sheet of Hot Mirror," *Edmund Optics*, 2016. [Online]. Available: <https://www.edmundoptics.com/f/high-performance-hot-mirrors/13824/>.